



NORTH AMERICA

732 North America Plug 2 pole STRAIGHT

STANDARD UL 817, CSA C22.2.21.95, NEMA 1 15

VOLTAGE 125V

CURRENT 15A



CABLE TYPE

HPN	2X18; 2X16
SPT-1	2X18
SPT-2	2X18; 2X16

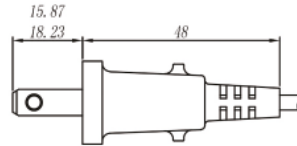
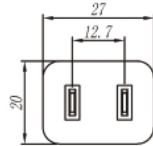

733 North America 2 pole Polarized STRAIGHT

STANDARD UL 817, CSA C22.2.21.95, NEMA 1 15

VOLTAGE 125V

CURRENT 15A



CABLE TYPE

HPN	2X18; 2X17; 2X16
SPT-1	2X18
SPT-2	2X18; 2X16

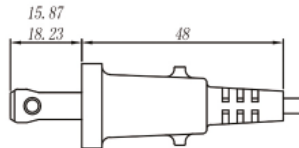
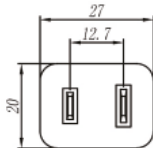

736B North America Plug 2 pole STRAIGHT

STANDARD UL 817, CSA C22.2.21, NEMA 1 15

VOLTAGE 125V

CURRENT 10A/12A/13A/15A



CABLE TYPE

SV- SVO	2X18;
SVT - SVTO - SVTOO	2X18; 2X17
SJT - SJTW	2X18; 2X16; 2X14
SJTO - SJTOW	2X18; 2X16; 2X14
SJTOO - SJTOOW	2X18; 2X16; 2X14
SJ - SJW	2X18; 2X16; 2X14
SJO - SJOW	2X18; 2X16; 2X14
SJOO - SJOOW	2X18; 2X16; 2X14
SPT -1	2X18
SPT -2	2X18; 2X16

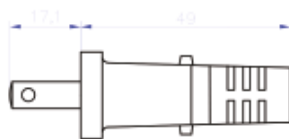
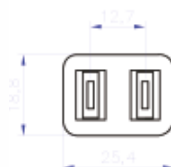

736B North America Plug 2 pole STRAIGHT with Grip

STANDARD UL 817, CSA C22.2.21, NEMA 1 15

VOLTAGE 125V

CURRENT 10A/12A/13A/15A

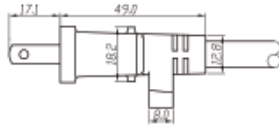
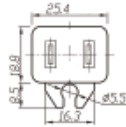

CABLE TYPE

SV- SVO	2X18;
SVT - SVTO - SVTOO	2X18; 2X17
SJT - SJTW	2X18; 2X16; 2X14
SJTO - SJTOW	2X18; 2X16; 2X14
SJTOO - SJTOOW	2X18; 2X16; 2X14
SJ - SJW	2X18; 2X16; 2X14
SJO - SJOW	2X18; 2X16; 2X14
SJOO - SJOOW	2X18; 2X16; 2X14
SPT -1	2X18
SPT -2	2X18; 2X16

737B North America 2-pole Polarized STRAIGHT

STANDARD UL 817, CSA C22.2.21, NEMA 1 15

VOLTAGE 125V

CURRENT 10A/12A/13A/15A

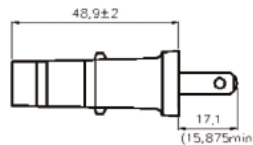
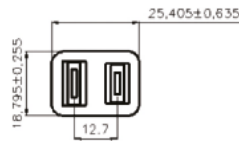

CABLE TYPE

SV- SVO	2X18;
SVT - SVTO - SVTOO	2X18; 2X17
SJT - SJTW	2X18; 2X16; 2X14
SJTO - SJTOW	2X18; 2X16; 2X14
SJTOO - SJTOOW	2X18; 2X16; 2X14
SJ - SJW	2X18; 2X16; 2X14
SJO - SJOW	2X18; 2X16; 2X14
SJOO - SJOOW	2X18; 2X16; 2X14
SPT -1	2X18
SPT -2	2X18; 2X16

737B North America Plug 2-pole Polarized STRAIGHT with GRIP

STANDARD UL 817, CSA C22.2.21, NEMA 1 15

VOLTAGE 125V

CURRENT 10A/12A/13A/15A

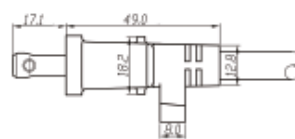
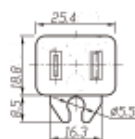

CABLE TYPE

SV- SVO	2X18;
SVT - SVTO - SVTOO	2X18; 2X17
SJT - SJTW	2X18; 2X16; 2X14
SJTO - SJTOW	2X18; 2X16; 2X14
SJTOO - SJTOOW	2X18; 2X16; 2X14
SJ - SJW	2X18; 2X16; 2X14
SJO - SJOW	2X18; 2X16; 2X14
SJOO - SJOOW	2X18; 2X16; 2X14
SPT -1	2X18
SPT -2	2X18; 2X16

729 North America Plug 2 pole + E ANGLED

STANDARD UL 817, CSA C22.2.21, NEMA 5 15

VOLTAGE 125V

CURRENT 10A

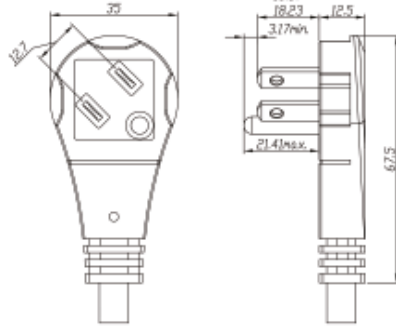

CABLE TYPE

SJT - SJTW	3X18
SJTO - SJTOW	3X18
SJTOO - SJTOOW	3X18

730 North America Plug 2 pole + E ANGLED

STANDARD UL 817, CSA C22.2.21, NEMA 5 15

VOLTAGE 125V

CURRENT 10A/13A/15A

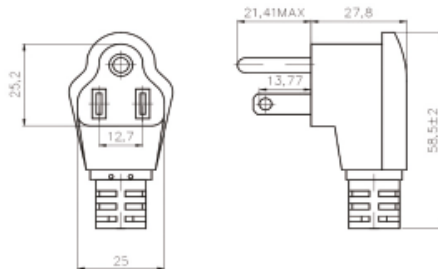

CABLE TYPE

SV- SVO	3X18;
SVT - SVTO - SVTOO	3X18; 3X16
SJT - SJTW	3X18; 3X16; 3X14
SJTO - SJTOW	3X18; 3X16; 3X14
SJTOO - SJTOOW	3X18; 3X16; 3X14
SJ - SJW	3X18; 3X16; 3X14
SJO - SJOW	3X18; 3X16; 3X14
SJOO - SJOOW	3X18; 3X16; 3X14
SPT -2	3X18; 3x16

731 North America Plug 2 pole + E ANGLED

STANDARD UL 817, CSA C22.2.21, NEMA 5 15

VOLTAGE 125V

CURRENT 10A/13A/15A

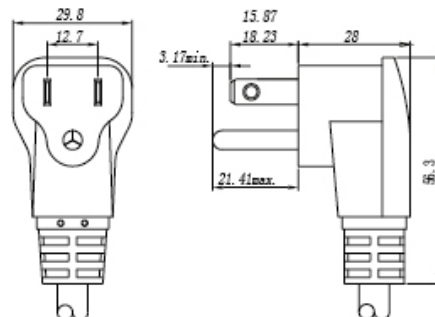

CABLE TYPE

SV- SVO	3X18;
SVT - SVTO - SVTOO	3X18; 3X16
SJT - SJTW	3X18; 3X16; 3X14
SJTO - SJTOW	3X18; 3X16; 3X14
SJTOO - SJTOOW	3X18; 3X16; 3X14
SJ - SJW	3X18; 3X16; 3X14
SJO - SJOW	3X18; 3X16; 3X14
SJOO - SJOOW	3X18; 3X16; 3X14
SPT -2	3X18; 3x16

738 North America Plug 2 pole + E STRAIGHT



STANDARD UL 817, CSA C22.2.21, NEMA 5 15

VOLTAGE 125V

CURRENT 10A/12A/13A/15A

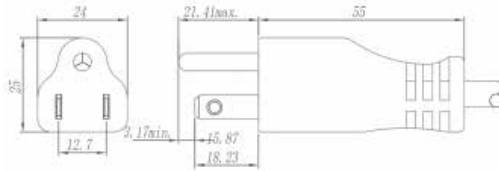

CABLE TYPE

SV- SVO	3X18; 3X16
SVT - SVTO - SVTOO	3X18; 3X16
SJT - SJTW	3X18; 3X16; 3X14
SJTO - SJTOW	3X18; 3X16; 3X14
SJTOO - SJTOOW	3X18; 3X16; 3X14
SJ - SJW	3X18; 3X16; 3X14
SJO - SJOW	3X18; 3X16; 3X14
SJOO - SJOOW	3X18; 3X16; 3X14
S - SW	3x16
SOW - SOO	3x16
SOO - SOOW	3x16
SPT -2	3X18
SJE - SJEW	3X18; 3X17;3X16; 3X14
SJEO - SJEOW	3X18; 3X17;3X16; 3X14
SJEOO - SJEOOW	3X18; 3X17;3X16; 3X14

739 North American Hospital Grade Plug 2-Pole+E STRAIGHT



STANDARD UL 817, CSA C22.2.21, NEMA 5 15

VOLTAGE 125V

CURRENT 10A/12A/13A/15A

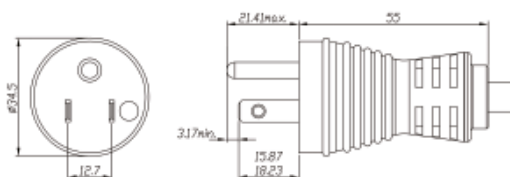

CABLE TYPE

SJT - SJTW	3X18; 3X17; 3X16 3X14; 3X12
SJTO - SJTOW	3X18; 3X17; 3X16 3X14; 3X12
SJTOO - SJTOOW	3X18; 3X17; 3X16 3X14; 3X12
ST - STW	3X18; 3X16; 3X14
STO - STOW	3X18; 3X16; 3X14
STOO - STOOW	3X18; 3X16; 3X14

902 ALCI 2 pole ANGLED

STANDARD UL 817
 VOLTAGE 125V
 CURRENT 15A



CABLE TYPE

On Demand

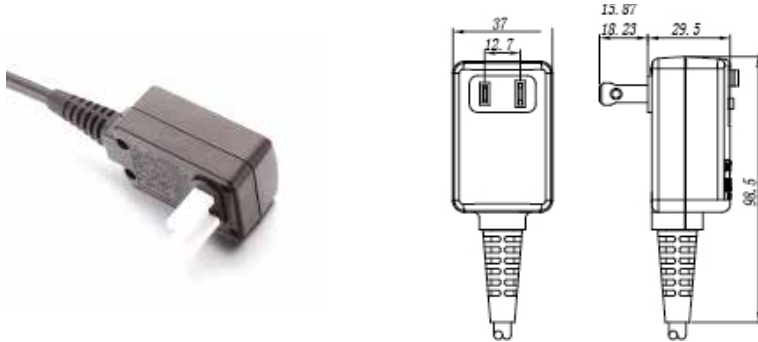

903 GFCI 2 pole + EARTH ANGLED

STANDARD UL 817
 VOLTAGE 125V
 CURRENT 15A



CABLE TYPE

SJT	3x18; 3X16; 3X14
SJTW	3x18; 3X16; 3X14

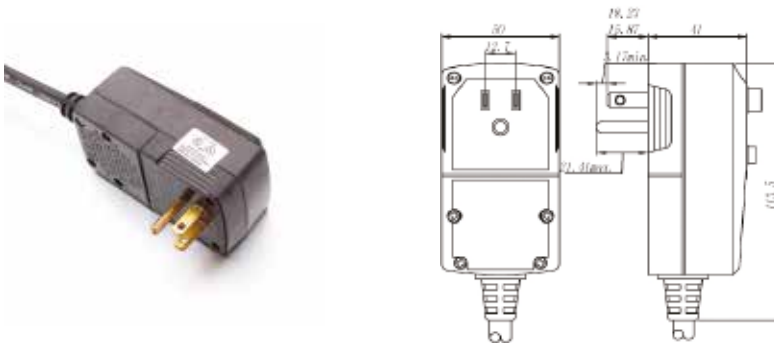

PC 520 North America Straight 3-pole

STANDARD UL 817, CSA C22.2.N.21-95, NEMA 5 20
 VOLTAGE 125V
 CURRENT 20A



CABLE TYPE

SJT - SJTW	3X18; 3X16; 3X14; 3X12
SJTO - SJTOW	3X18; 3X16; 3X14; 3X12
SJTOO - SJTOOW	3X18; 3X16; 3X14; 3X12
SJOO - SJOOW	3X18; 3X16; 3X14; 3X12
SJ - SJO - SJOW	3X18; 3X16; 3X14; 3X12
ST - STW	3X18; 3X16; 3X14;
STO - STOW	3X18; 3X16; 3X14;
STOO - STOOW	3X18; 3X16; 3X14;

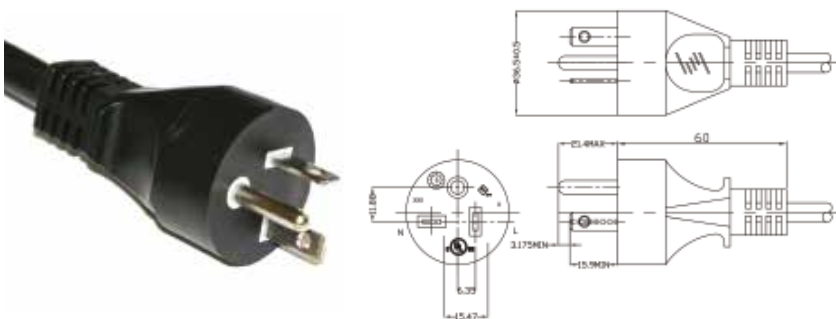

PC 615 North America Straight 3-pole

STANDARD UL 817, CSA C22.2.N.21-95, NEMA 6 15

VOLTAGE 250V

CURRENT 15A

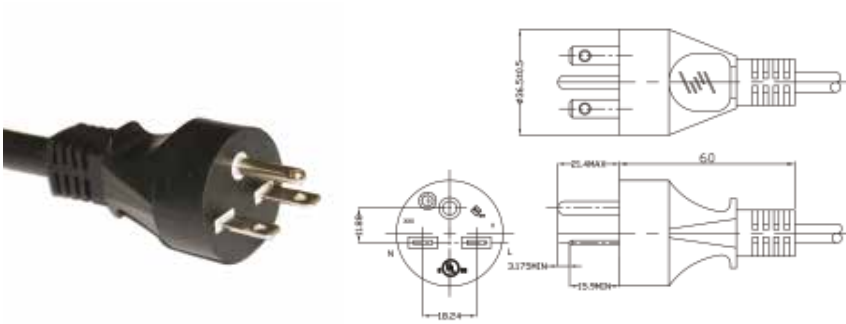

CABLE TYPE

SJT - SJTW	3X18; 3X16; 3X14; 3X12
SJTO - SJTOW	3X18; 3X16; 3X14; 3X12
SJTOO - SJTOOW	3X18; 3X16; 3X14; 3X12
SJOO - SJOOW	3X18; 3X16; 3X14; 3X12
SJ - SJO - SJOW	3X18; 3X16; 3X14; 3X12
ST - STW	3X18; 3X16; 3X14;
STO - STOW	3X18; 3X16; 3X14;
STOO - STOOW	3X18; 3X16; 3X14;

PC 620 North America Straight 3-pole

STANDARD UL 817, CSA C22.2.N.21-95, NEMA 6 20

VOLTAGE 250V

CURRENT 20A

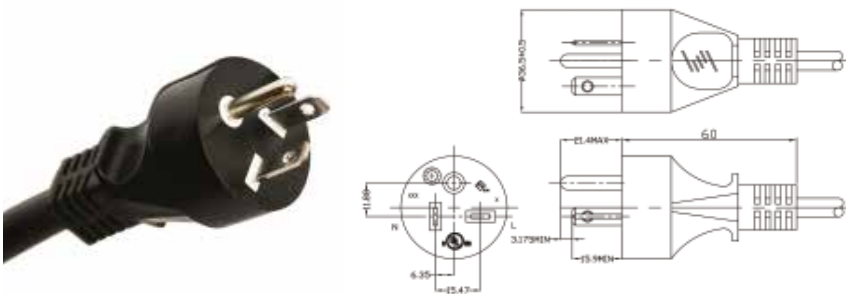

CABLE TYPE

SJT - SJTW	3X18; 3X16; 3X14; 3X12
SJTO - SJTOW	3X18; 3X16; 3X14; 3X12
SJTOO - SJTOOW	3X18; 3X16; 3X14; 3X12
SJOO - SJOOW	3X18; 3X16; 3X14; 3X12
SJ - SJO - SJOW	3X18; 3X16; 3X14; 3X12
ST - STW	3X18; 3X16; 3X14;
STO - STOW	3X18; 3X16; 3X14;
STOO - STOOW	3X18; 3X16; 3X14;

